

---

# SCLAK

Safer and smarter locks

1. LOCATE YOUR LOCK
2. CHECK THE CONTENTS OF THE BOX
3. POSITION THE SCLAK UNIT
4. DRILL HOLES AND FIX THE UNIT
5. INSERT CABLES
6. CONNECT THE UNIT
7. ACTIVATE SCLAK

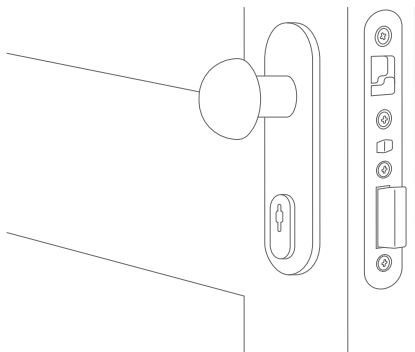

## 1. LOCATE YOUR LOCK

Locate the lock you wish to use with SCLAK. Locate the power cord and check that it is correctly connected to a 12/24V DC-AC power source. Ensure there are control and opening buttons.

1xScrewdriver with T8 TORX and 3mm SLOT heads

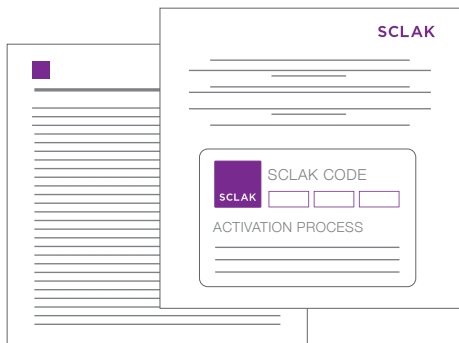
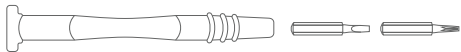

## 2. CHECK THE CONTENTS OF THE BOX

SCLAK unit, 4xT8 TORX screws for SCLAK unit, 2xseals, 1xJumper (possible to use with terminal boards), 2xWood screws, 2xIron screws, 2xWall plugs, 50cm power cable, Warranty, 1xDouble-sided adhesive, 2xWall plugs, 1xScrewdriver with T8 TORX and 3mm SLOT heads and 1XSCLAK sticker.

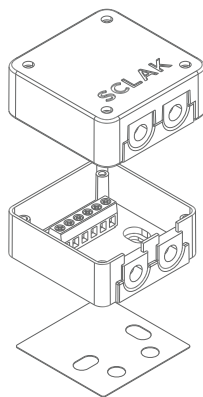

SCLAK cover

base and connections

1 double-sided adhesive



2xIron screws



2xWood screws



4xT8 TORX screws



2xWall plugs

warranty



1 jumper



1 sticker

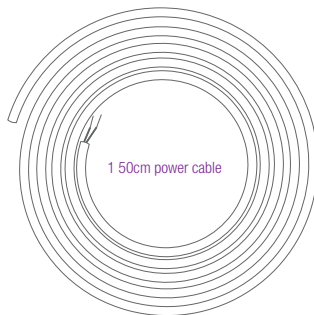

1 50cm power cable

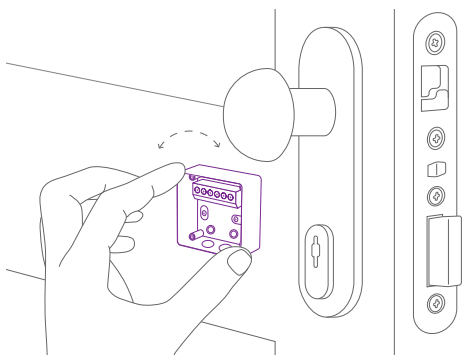

### 3. POSITION THE SCLAK UNIT

Place the SCLAK unit in the correct position for installation. For best results we recommend positioning the unit close to the existing lock. If this not possible, then position it close to the relevant switch.

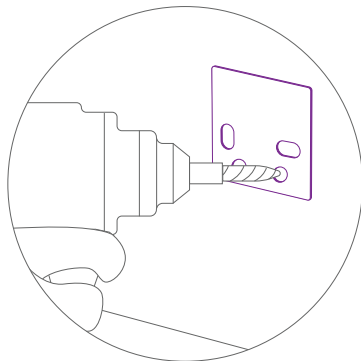

### 4. DRILL HOLES AND FIX THE UNIT

After positioning the SCLAK unit with the double-sided adhesive, drill holes to correctly fix the unit to the base. The base can be fixed to wooden or metallic doorframes or to walls using the appropriate supplied screws.

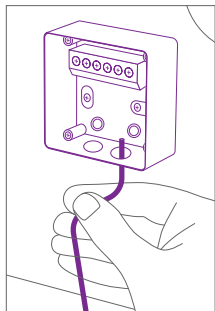

Fig.A

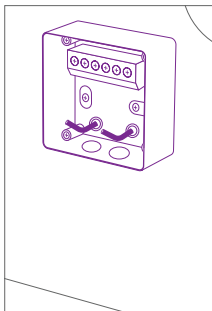

Fig.B

### 5. INSERT CABLES

The power and connection cables can now be inserted into the base either through the holes on the bottom side (Fig.A) or on the base of the SCLAK unit (Fig.B). Use the most appropriate holes.

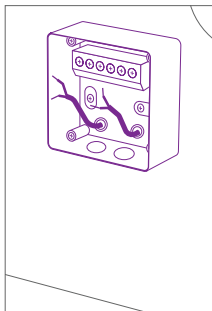

Fig.C

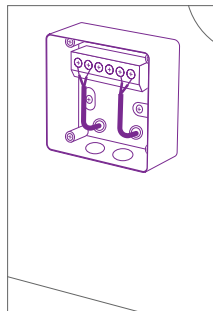
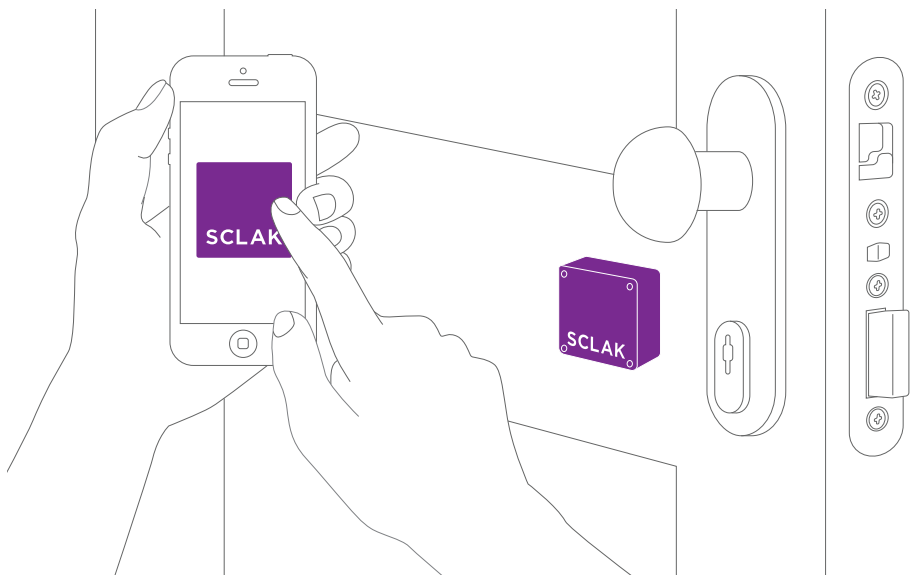

Fig.D

### 6. CONNECT THE BASE

Connect the cables to the appropriate terminal using the above illustration (Fig.C and Fig.D). Please ensure the wires are correctly connected before proceeding with the test.



## 7. ACTIVATE SCLAK

Place the SCLAK cover over the base unit, ensuring that the contact points are correctly aligned. Check that the LED lights are working correctly and secure the unit with the 4 supplied screws.

## COMPATIBILITY

SCLAK is compatible with every kind of electronic lock; it can be used with existing access registration systems, including traditional keys. It does not require an Internet connection.

It works with all smartphones with Bluetooth 4.0 running iOS 8 or above, Android 4.3 or above.



FOR ADDITIONAL INFORMATION VISIT [WWW.SCLAK.COM](http://WWW.SCLAK.COM)

## CONNECTION GUIDE

Remove the lock cover, disconnect the power cable and connect this to the SCLAK unit. Use another cable to connect the SCLAK unit to the lock. Use the following illustration to select the correct connection option for your lock.

### ① STANDARD SCLAK CONNECTION

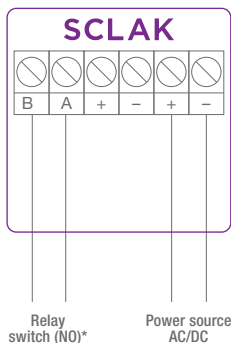

\*Normally open contact

### ② CONNECTING TO AN ELECTROMECHANICAL LOCK

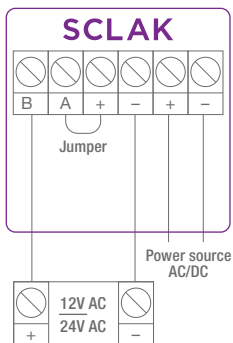

ELECTRONIC LOCK

### ③ CONNECTION WITH STANDARD BLOCK MOTORIZED

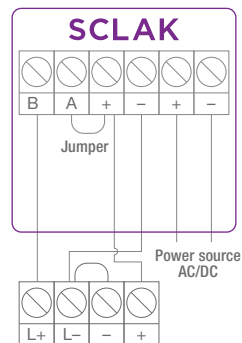

ELECTRONIC LOCK WITH FIXED POWER SOURCE

## TECHNICAL SPECIFICATIONS

SIZE	50x50x24 mm
POWER	AC-DC 12-24V (+ e - with terminal boards)
POWER CONSUMPTION	Max 1W
OUTPUT	Impulse Relay NO (A and B with terminal boards)
MAX OUTPUT CURRENT	1A

CERTIFICATE OF APPROVAL	CE conformity marking
OPERATING TEMPERATURE	-20 + 60° C
FREQUENCY	2.4 GHz
PROTECTION	IP 44 if installed correctly
CONNECTIVITY	Bluetooth 4.1 BT

---

## **SCLAK Srl**

Galleria Pattari, 2  
20121 Milano, Italia  
Tel. +39 02 36532958  
Fax +39 02 36533039  
[info@sclak.com](mailto:info@sclak.com)  
[www.sclak.com](http://www.sclak.com)